

ISOMETRIC VIEW

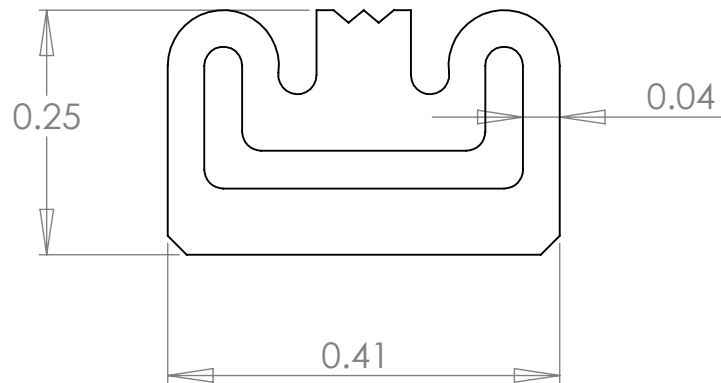

Standard Materials:
SILICONE

Optional Materials: Setup May Apply
EPDM
NEOPRENE
NITRILE
BUTYL
FKM

Available Corners: Face/Axial Seals
Not Available - Setup May Apply

Bend Radius:
Min. Dia. = 4" ID

PROPRIETARY AND CONFIDENTIAL
THE INFORMATION CONTAINED IN THIS DRAWING IS THE SOLE PROPERTY OF DYNAMIC RUBBER, INC. ANY REPRODUCTION IN PART OR AS A WHOLE WITHOUT THE WRITTEN PERMISSION OF DYNAMIC RUBBER, INC. IS PROHIBITED.

		UNLESS OTHERWISE SPECIFIED:	NAME	DATE
		DIMENSIONS ARE IN MILLIMETERS	DRAWN	T. Thompson
		TOLERANCES:	CHECKED	
		FRACTIONAL ±	ENG APPR.	
		ANGULAR: MACH ± BEND ±	MFG APPR.	
		TWO PLACE DECIMAL ±	Q.A.	
		THREE PLACE DECIMAL ±	COMMENTS:	
		INTERPRET GEOMETRIC TOLERANCING PER:		
		MATERIAL		
		FINISH		
NEXT ASSY	USED ON			
APPLICATION		DO NOT SCALE DRAWING		



SIZE	DWG. NO.	REV
A	DR37_SEAL	1
SCALE: 1:2	WEIGHT:	SHEET 1 OF 1